



FILTRATION

DFE . . . The Evolution in Filter Element Multi-Pass Development Testing Hy-Pro's Competitive Advantage



Fluxa Filtri S.p.A.

V.le A.De Gasperi, 88/B - 20017 Mazzo di Rho (MI) Italy
Tel. +39 02.93959.1 (15 linee) Fax +39 02.93959.400/440/470
e-mail: info@fluxafiltri.com - www.fluxafiltri.com

What is DFE (Dynamic Filter Efficiency)?

All hydraulic and lube systems have a critical contamination tolerance level that is often defined by, but not limited to, the most sensitive system component such as servo valves or high speed journal bearings. Component manufacturers provide fluid cleanliness levels, per ISO4406 or ISO4406:1999, required for optimum performance and predictable life. An operating system is at risk whenever the critical contamination level is exceeded. Contamination levels determine the individual component's wear rate (useful life) and ability to perform as intended (functionality).

System design, filter performance and maintenance practices largely determine the contamination level in a system. Filters are expected to maintain contamination below critical tolerance levels. Filter performance in a dynamic operating system is variable based upon flow rate and flow density, changes in flow rate (duty cycle), viscosity, fluid and structure borne vibration (Hz), contamination levels, ingress rate and several other conditions. All filters are subjected to some form of system dynamics. Hydraulic filters encounter frequent and rapid changes in flow rate accompanied by frequency changes. Lube filters typically experience dynamic conditions during start up and shut down. Two key characteristics of filter performance are capture efficiency and retention efficiency. Capture efficiency can be thought of simply as how effectively a filter captures particles while retention efficiency is a measure of how effectively that filter retains the particles it has captured. A filter is not a black hole, and its performance must not be based solely on how efficiently it captures particles. If not properly designed and applied, a filter can become one of the most damaging sources of contamination in a system.



The Dynamic Filter Efficiency Test (DFE) is the evolution of hydraulic and lube filter performance testing. The DFE test goes further than current industry standards to bridge the gap between lab and real world by inducing dynamic duty cycles and measuring real-time performance before, during and after the cycles. DFE testing quantifies both capture and retention efficiency in real time so that we may predict the worst case fluid cleanliness along with average fluid cleanliness. The DFE test method was pioneered in 1998 during a joint effort between Scientific Services Inc (SSI) and Hy-Pro Filtration.

Current Filter Performance Testing Methods

Manufacturers of filter assemblies and filter elements use an industry standard test to rate filter efficiency and dirt holding capacity of filter elements under ideal lab conditions. The test protocol is ISO standard ISO16889 multi-pass, and was updated from ISO 4572 in 1999. The standard provides a repeatable test method where identical filters should produce like results when tested on various test stands. Figure 1 depicts the test circuit where MIL-H-5606 hydraulic fluid is circulated at a constant flow rate in a closed loop system with the test filter and on-line particle counters before and after the filter. Contaminated fluid with a known quantity of contaminant is added to the system before the upstream particle counter, and at a constant rate. Small amounts of fluid are removed before and after the filter for particle counting to calculate the filter efficiency (capture). The capture efficiency is expressed as the Filtration Ratio (Beta) which is the relationship between the number of particles greater than and equal to a specified size ($x_{\mu m(c)}$) counted before and after the filter.

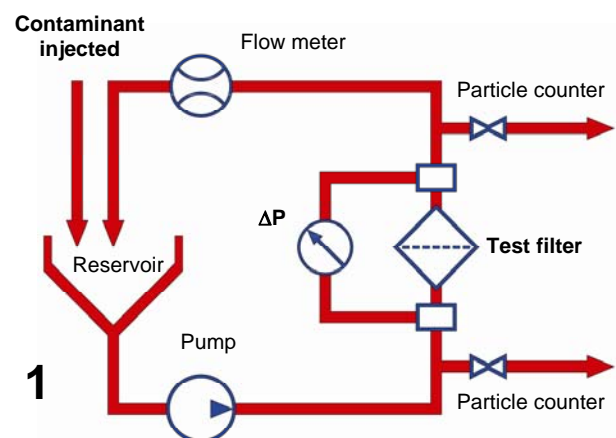

Filtration Ratio (Beta) per ISO16889:

$$\beta_{x[\mu]} = \frac{\text{quantity particles } \geq x_{\mu[\mu]} \text{ upstream of filter}}{\text{quantity particles } \geq x_{\mu[\mu]} \text{ downstream of filter}}$$

Example: $\beta_{7[\mu]} = 600/4 = 150$, Filtration Ratio (Beta): $\beta_{7[\mu]} = 150$.

In the example, 600 particles greater than or equal to $7_{\mu[\mu]}$ were counted upstream of the filter and 4 were counted downstream. This Filtration Ratio is expressed as “Beta $7_{[\mu]} = 150$ ”. The $_{[\mu]}$ is referred to as “sub c”. The sub c is used to differentiate between multi-pass tests run per the current ISO16889 multi-pass test with new particle counter calibration per ISO11171 from ISO4572. Filtration Ratio expressed or written without the “sub c” refers to the antiquated ISO4572 multi-pass test superseded by ISO16889.

The efficiency may also be expressed as a percentage by converting the Filtration Ratio:

$\beta_{7[\mu]} = 150 = (\beta - 1) / \beta \times 100$, Efficiency percentage of $\beta_{7[\mu]} = 150 = (150 - 1) / 150 \times 100 = 99.33\%$. The test filter is 99.33% efficient at capturing particles $7_{\mu[\mu]}$ and larger.

The DFE Multi-pass Testing Method

DFE multi-pass enhances the industry standard by inducing dynamic conditions (duty cycle) and measuring the affects of the duty cycle in real time instead of looking at normalized numbers over a time weighted average. DFE also addresses the inherent problem of ISO16889 where fluid is added and removed throughout the test, thus creating a small mathematical error that must be corrected in final calculations. In addition to the capture efficiency, DFE also quantifies retention efficiency in real time. A filter that does not properly retain previously captured contaminant can be identified. The phenomenon of releasing captured contaminant is called unloading, and can result in temporary contamination levels that are well above the critical contamination tolerance level of a system.

The DFE test circuit also utilizes upstream and downstream particle counters, test filter and injection point before the upstream particle counter much like ISO16889. That is where the similarity to ISO16889 ends. The DFE flow rate is not constant like ISO16889, but rather hydrostatically controlled so flow changes can be made quickly while maintaining full system flow through the test filter. Particle counter sensor flows remain constant during all particle counts and no intermediate reservoirs are used to collect the particle counter flow before it is counted. This ensures that the fluid counted is representative of the system contamination level. Counts are taken before, during, and after each flow change. The total number of particle counts is determined by the duty cycle of the specific test. The efficiency results are reported in Filtration Ratio (Beta), efficiency percentage and actual particle levels per milliliter.

The raw data is digitally tagged so filter efficiency may be reported for various combinations of flow conditions as a time weighted average and specific ranges related to differential pressure across the filter element. Some typical combinations include all maximum flow counts, all low flow counts and all flow change counts (low to high or high to low). Rapid particle counting with proper timing is how DFE allows Hy-Pro to analyze and understand both capture efficiency and retention efficiency characteristics of each filter tested while contaminant is being introduced upstream of the filter or when there is no contaminant being injected.

The DFE Testing Method - Quantifying Contaminant Capture and Retention

Figure 2 compares the performance of two identical high efficiency glass media filter elements produced by the same manufacturer, one of which was tested per ISO16889 multi-pass and the other per the DFE multi-pass method. The graph expresses the actual number of particles $6\mu_{[c]}$ and larger counted downstream of the filter element from several data points during the tests.

Filter Element	A1	A2
Element Rating	$\beta_{7[c]} > 1000$	$\beta_{7[c]} > 1000$
High Flow (lpm)	112	112
Low Flow (lpm)	56	-
Contaminant Injection Rate	3 mg/l	3 mg/l

Filter A2 was tested at a constant flow rate and maintained a steady efficiency throughout the test. Filter A1 was cycled between the max rated flow rate and half of rated flow with a duty cycle consistent with that of a hydraulic system. The downstream counts for Filter A1 varied and were highest during changes from low flow to high flow. The peaks represent counts taken during flow change and the valleys represent counts taken after each flow change. The alternating high peaks represent counts taken during changes from low flow to high flow. As the amount of contaminant captured by Filter A1 increased, the downstream counts increased most dramatically during the flow changes from low flow to high flow. Filter element A1, not properly designed to retain previously captured contaminant during dynamic system conditions, can become a dangerous source of contamination as it captures and then releases concentrated clouds of contaminated fluid.

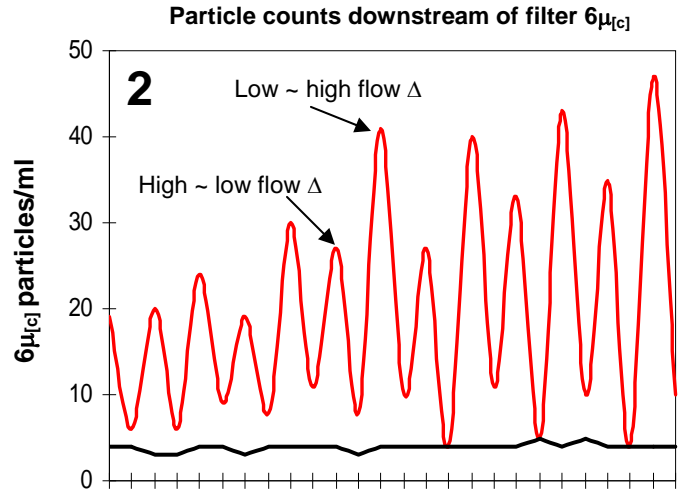
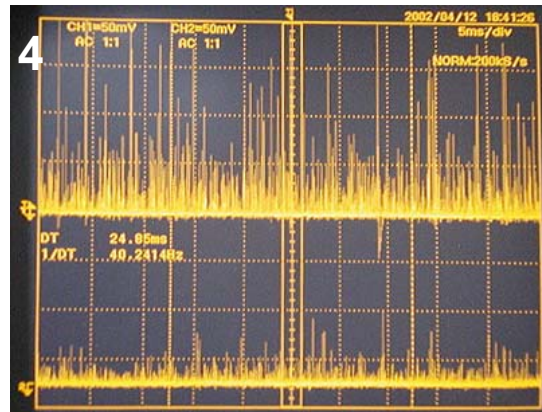
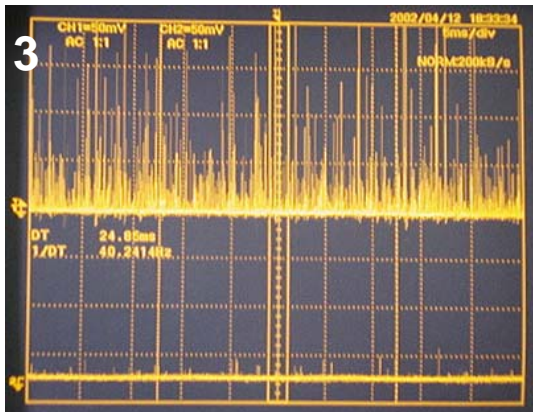

Figure 3 shows the particle counter raw data (top-upstream, bottom-downstream) for Element A1 before a change from low flow to high flow and Figure 4 shows the particle counter data for Element A1 during a change from low flow to high flow. The downstream particle count trace during the change reveals a much higher quantity of smaller particles and larger particles that did not pass the element before the dynamic system condition. This phenomenon can best be described as “contaminant unloading”. As the filter element captures more dirt, greater amounts may be released back into the system that it is installed to protect when the element is subjected to a dynamic flow condition and change in differential pressure across the element. Unloading may also occur when the flow rate changes from high flow to low flow, represented by the alternating smaller peaks in Figure 3. The filter element typically recovers shortly after the dynamic condition, but highly contaminated clouds of fluid from contaminant unloading can cause severe component damage and unreliable system performance.



The DFE Testing Method - Quantifying Contaminant Capture and Retention

Excessive unloading in the early stage of element life may be symptomatic of an element that will eventually fail and lose its efficiency all together (media breakdown). Filter element B (graph 9) performed true to its rating under the ISO16889 multi-pass and achieved a beta ratio in excess of $\beta_{7[\mu c]} > 1000$. However, when an identical element was tested per DFE multi-pass the beta ratio slipped well below the element rating during dynamic conditions (graph 11). Filter media selection is often based on the beta ratio rating published by filter manufacturers. The beta ratio is the product of the ISO16889 multi-pass test and does not account for the dynamic duty cycle of hydraulic systems since the flow rate condition remains constant throughout the test. A common result is a system that suffers from premature contamination related failures, even though it is protected by filters that in theory should prevent such failures, causing reduced uptime, unreliable equipment performance, and expensive component repair and replacement costs.

Figure 5 compares the performance of two identical Hy-Pro filter elements manufactured with G8 Dualglass media which have been designed and developed per the DFE multi-pass test method. All Hy-Pro elements that utilize the G8 or higher media carry the Hy-Pro DFE rating.

Filter Element	Hy-Pro 1	Hy-Pro 2
Element Rating	$\beta_{7[\mu c]} > 1000$	$\beta_{7[\mu c]} > 1000$
High Flow (lpm)	112	112
Low Flow (lpm)	56	-
Contaminant Injection Rate	3 mg/l	3 mg/l

Although the contaminant unloading effect is still evident, the unloading is insignificant as filter element Hy-Pro 1, tested per DFE, performed true to its ISO16889 multi-pass rating of $\beta_{7[\mu c]} > 1000$ even during dynamic flow conditions.

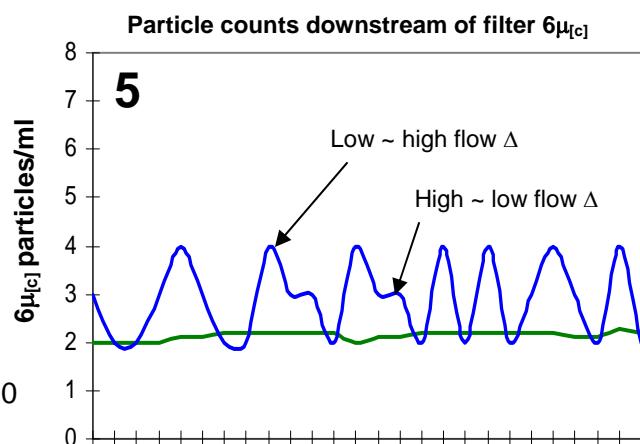
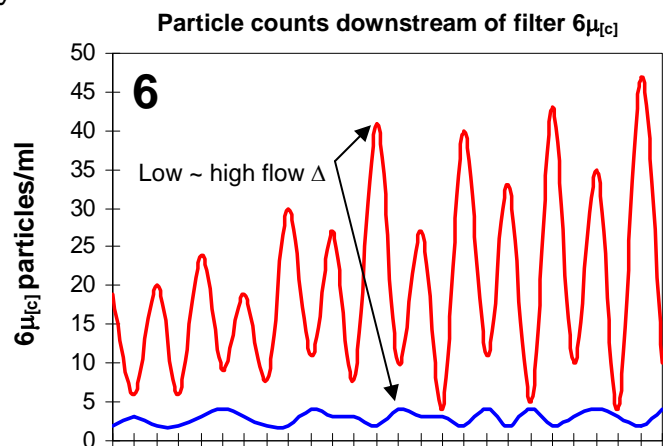

Figure 6 compares the performance of filter Element A1 and Hy-Pro 1 (DFE rated). Both elements demonstrated excellent particle capture performance during the ISO16889 and DFE testing. The DFE rated Hy-Pro element yielded much more stable particle counts downstream of the element and more consistent efficiency during the dynamic flow conditions. Improving particle retention results in more predictable fluid cleanliness levels and a system that can continually operate below the critical contamination tolerance level.

Filter Element	Element A1	Hy-Pro 1
Element Rating	$\beta_{7[\mu c]} > 1000$	$\beta_{7[\mu c]} > 1000$
High Flow (lpm)	112	112
Low Flow (lpm)	56	56
Contaminant Injection Rate	3 mg/l	3 mg/l



The DFE Multi-pass Testing Method - Cold Start Contaminant Retention

Once the element has captured enough contaminant to reach approximately 90% of the terminal ΔP , dirty filter indicator setting, the main flow goes to zero and the injection system is turned off for a short dwell period. The main flow pump is turned on and rapidly achieves maximum element rated flow accompanied by real time particle count to measure retention efficiency of the contaminant loaded element.

After the start-up simulation the system continues to perform the test duty cycle to further monitor the retention efficiency of the filter element after a restart. The purpose of this portion of the DFE test is to quantify how well the filter element retains the contaminant it has previously captured when subjected to a start-up condition. The dwell before the restart may be a function of time or a function of system temperature to simulate cold restart with an element that has captured a substantial amount of contaminant.

Figure 7 and the table below it show the performance of an element, from the same lot as filter elements A1 & A2 from figure 2, that was subjected to the DFE restart test. During the restart, particle counts after the filter increased by a factor of 20 on the $6\mu_{[c]}$ channel, and the ISO codes increased by 4 on the $4\mu_{[c]}$ and $6\mu_{[c]}$ channels. During the restart test there is no contaminant being injected so any particles measured were already in the system or were released by the element (unloading).

The result is a temporary state of highly contaminated fluid that has resulted because the filter element did not properly retain the dirt.

Downstream Element A3	$4\mu_{[c]}$ particles/ml	$6\mu_{[c]}$ particles/ml	$14\mu_{[c]}$ particles/ml	ISO Code per ISO4406:1999
Before Restart	429	136	25	16/14/12
During Restart	6973	2802	139	20/18/14

Figure 8 and the table below it show the performance of Hy-Pro element 3, which is from the same lot as Hy-Pro 1 and 2 from figure 5. The unloading is evident in the DFE rated Hy-Pro 3 element, but the affect is greatly reduced. Element A3 (figure 7) unloaded 7 times more particles $6\mu_{[c]}$ and larger than did Hy-Pro 3, and 35 times more particles $14\mu_{[c]}$ and larger. The DFE rated Hy-Pro element had much higher retention efficiency than the filter designed and validated only to ISO16889 multi-pass.

If we assume that a filter is like a black hole where all of the captured contaminant will remain trapped indefinitely we are operating with a false sense of security. If you are only discussing removal (capture) efficiency when it comes to filter elements you need to be looking at particle retention efficiency as well.

Downstream Element Hy-Pro 3	$4\mu_{[c]}$ particles/ml	$6\mu_{[c]}$ particles/ml	$14\mu_{[c]}$ particles/ml	ISO Code per ISO4406:1999
Before Restart	75	10	1	13/11/7
During Restart	2994	404	4	19/16/9

Particle counts downstream of filter

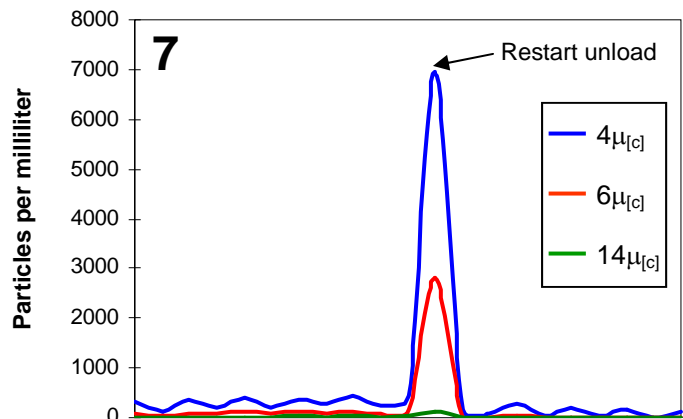

Particle counts downstream of filter

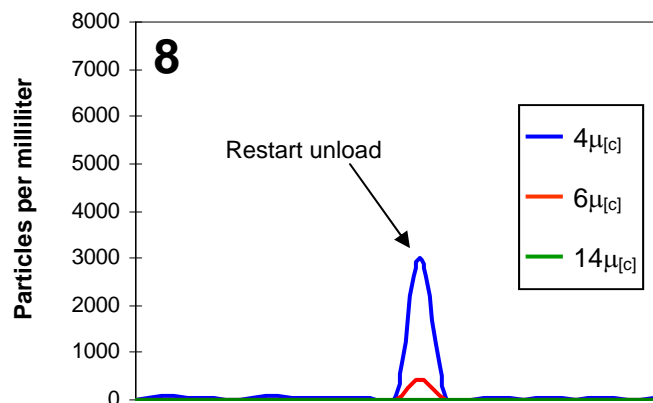

DFE - Comparison Between DFE and ISO 16889 Multi-Pass Test Results

Figure 9 shows the performance of like elements produced by three different manufacturers that were tested per ISO 16889 multi-pass. The results were expressed as a time weighted beta ratio. Element B had a better capture efficiency than the Hy-Pro element in the constant flow test environment of ISO 16889. All of the elements tested were true to their Beta Ratio of either $\beta_{5\mu[m]} > 200$ or 1000.

Time Weighted Beta Ratio Comparison per ISO16889 multi-pass for $\beta_{5\mu[m]} > 200$ or 1000 filter element.

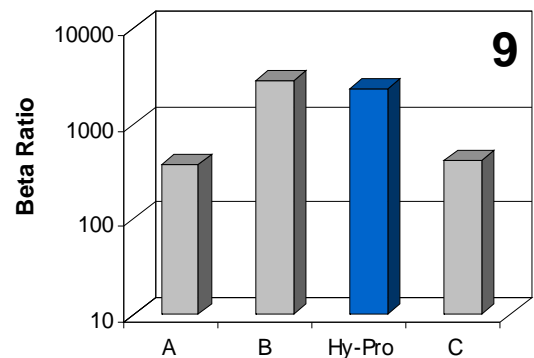

Time Weighted Beta Ratio Comparison per DFE multi-pass for $\beta_{5\mu[m]} > 200$ or 1000 filter element.

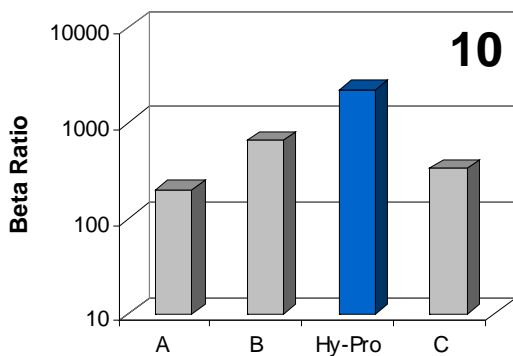
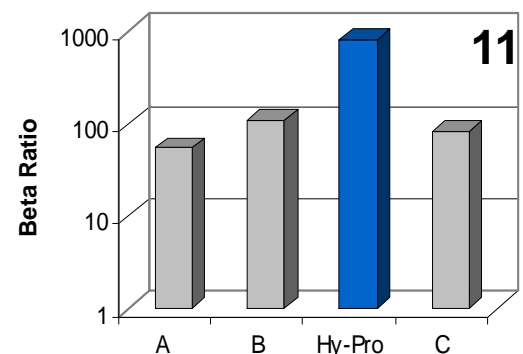

Figure 10 shows the time weighted performance of the like elements tested per DFE multi-pass. To illustrate the performance differences between DFE and ISO16889, the two tests were run similarly with the only difference being the DFE test flow rate. The flow through the element was cycled up and down the operating range to simulate a real world hydraulic system duty cycle. The time weighted beta ratio for elements A and B was below the rated beta ratio while elements Hy-Pro and C performed true to rating.

In figure 11 the particle counts taken during flow change have been isolated and then averaged to yield a beta ratio during transient flow. Since the DFE test has shown that filter element performance is at it's worst during flow changes isolating those sequences can help predict performance in dynamic flow systems. It is with this graph that we see how overall filter performance can be affected by systems with cyclic flow.

Real Time Flow Δ Beta Ratio Comparison per DFE multi-pass for $\beta_{5\mu[m]} > 200$ or 1000 filter element.



Element B had a beta ratio in excess of $\beta_{7\mu[m]} > 2000$ when tested per ISO16889 (figure 9). However, figure 11 shows the average beta ratio of Element B during variable flow to be less than $\beta_{7\mu[m]} > 100$. The Hy-Pro element beta ratio was in excess of $\beta_{7\mu[m]} > 800$ and was the only one with a beta ratio greater than 100. The Hy-Pro performance in figure 11 illustrates why Hy-Pro is committed to the DFE test method for design and development.

Relying solely on ISO16889 to predict how filter elements will perform in systems with dynamic flow conditions means that we are making decisions on filter performance without all of the available information. The current industry standard test for hydraulic and lube filter performance (ISO 16889) is a good tool for predicting performance of off-line filters and circulating systems, but does not accurately represent the stress of a hydraulic circuit with dynamic flow conditions or a lube system cold start condition. The first step to fixing a problem is acknowledging that a problem actually exists, and without DFE testing it is difficult to truly predict actual filter performance in a dynamic system.

Understanding ISO Codes - The ISO cleanliness code (per ISO4406-1999) is used to quantify particulate contamination levels per milliliter of fluid at 3 sizes $4\mu_{[c]}$, $6\mu_{[c]}$ and $14\mu_{[c]}$. The ISO code is expressed in 3 numbers (example: 19/17/14). Each number represents a contaminant level code for the correlating particle size. The code includes all particles of the specified size and larger. It is important to note that each time a code increases the quantity range of particles is doubling.

ISO 4406:1999 Code Chart		
Range Code	Particles per milliliter	
	More than	Up to/including
24	80000	160000
23	40000	80000
22	20000	40000
21	10000	20000
20	5000	10000
19	2500	5000
18	1300	2500
17	640	1300
16	320	640
15	160	320
14	80	160
13	40	80
12	20	40
11	10	20
10	5	10
9	2.5	5
8	1.3	2.5
7	0.64	1.3
6	0.32	0.64

Particle Size	Particles per milliliter	ISO 4406 Code range	ISO Code
$4\mu_{[c]}$	151773	80000~160000	24
$6\mu_{[c]}$	38363	20000~40000	22
$10\mu_{[c]}$	8229		
$14\mu_{[c]}$	3339	2500~5000	19
$21\mu_{[c]}$	1048		
$38\mu_{[c]}$	112		

Particle Size	Particles per milliliter	ISO 4406 Code range	ISO Code
$4\mu_{[c]}$	492	320 ~ 640	16
$6\mu_{[c]}$	149	80 ~ 160	14
$10\mu_{[c]}$	41		
$14\mu_{[c]}$	15	10 ~ 20	11
$21\mu_{[c]}$	5		
$38\mu_{[c]}$	1		

Succeed with a Total Systems Cleanliness Approach

Developing a Total System Cleanliness approach to control contamination and care for fluids from arrival to disposal will ultimately result in more reliable plant operation and save money. Several steps to achieve Total Systems Cleanliness include: evaluate and survey all hydraulic and lubrication systems, establish an oil analysis program and schedule, insist on specific fluid cleanliness levels for all new fluids, establish a baseline and target fluid cleanliness for each system, filter all new fluids upon arrival and during transfer, seal all reservoirs and bulk tanks, install high quality particulate and desiccant breathers, enhance air and liquid filtration on existing systems wherever suitable, use portable or permanent off-line filtration to enhance existing filtration, improve bulk oil storage and handling during transfer, remove water, and make a commitment to fluid cleanliness.

The visible cost of proper contamination control and total systems cleanliness is less than 3% of the total cost of contamination when not kept under control. Keep your head above the surface and avoid the resource draining costs associated with fluid contamination issues including:

- Downtime and lost production
- Component repair/replacement
- Reduced useful fluid life
- Wasted materials and supplies (\$)
- Root cause analysis meetings
- Maintenance labor costs
- Unreliable machine performance
- Wasted time and energy (\$)

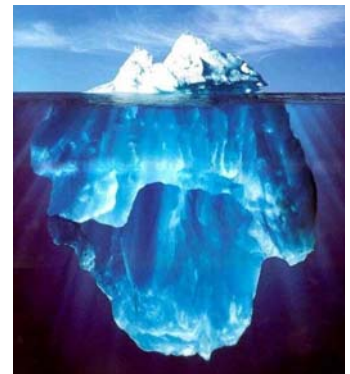

Fluxa Filtri S.p.A.

V.le A.De Gasperi, 88/B - 20017 Mazzo di Rho (MI) Italy
 Tel. +39 02.93959.1 (15 linee) Fax +39 02.93959.400/440/470
 e-mail: info@fluxafiltri.com - www.fluxafiltri.com